

CW1H

600mm One Hole Gas Waterless Woks

CW1H-C 1 Hole, 1 Chimney Burner

CW1H-D 1 Hole, 1 Duckbill Burner



CW1H

- 800mm compact depth
- Cobra suite matching
- Waterless wok deck
- 14" wok hole
- Duckbill and Chimney burner model options
- 105 MJ/hr 18 jet Duckbill burners¹
- 95 MJ/hr 24 jet Chimney burners
- High splashback with shelf
- Water folding laundry arm on splashback
- Rear waste channel
- Stainless steel spill tray
- Lift out wok ring
- Flame failure protection with pilot burner

Also Available



CW2H



CW3H

OVERALL CONSTRUCTION

- Full chassis construction
- Double skin insulated wok deck
- Stainless steel exterior finish
- Heavy-duty cast iron wok rings (removable)
- Stainless steel spill tray
- 63mm dia. stainless steel legs with adjustable feet

CONTROLS

- Pilot On/Off control with flame failure valve
- Main burner On/Off valve with High-Low burner adjustment
- Quarter turn main burner control handles
- Quarter turn water valve handle

CLEANING AND SERVICING

- Stainless steel exterior finish
- Lift out wok rings for full cleaning ability
- Slide out spill tray
- Rear waste channel with removable grate for debris collection
- Access to all parts from front and top for servicing



Duckbill burner



Chimney burner

¹ NZ models Duckbill burner rating 105MJ/hr Natural Gas / 85MJ/hr on LP gas.

Matching Products



CSP6

CN4

CT9

CP4

CS9 / C900-S

C6B

CR9D

CR6C

CF4

C9C

CW1H

600mm One Hole Gas Waterless Woks

CW1H-C 1 Hole, 1 Chimney Burner

CW1H-D 1 Hole, 1 Duckbill Burner

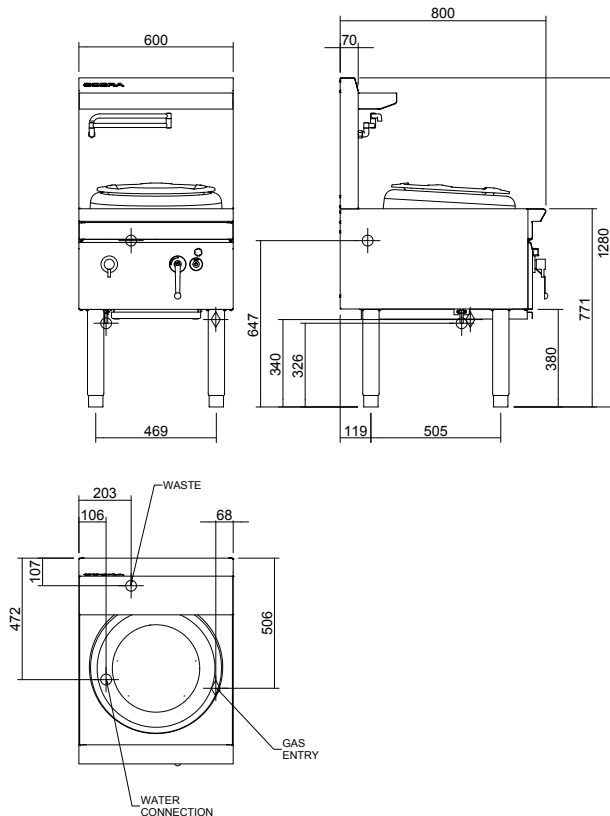

CW1H

SPECIFICATIONS

Burners

95MJ/hr 24 jet Chimney burner
105MJ/hr 18 jet Duckbill burner
(NZ - LP gas rating 85 MJ/hr)

Gas Rating - Total

CW1H-C 95 MJ/hr
CW1H-D 105 MJ/hr
(NZ- LP gas rating 85 MJ/hr)

Wok size

14" wok ring
Suits woks 40-60cm / 16-24"

Gas connection

R3/4 (BSP) male each wok hole
506mm for rear, 506mm from floor, 68mm from RH side

All units supplied with Natural-LP gas regulators for each wok connection
Supplied gas regulators include Test Point for appliance operating pressure
Supplied regulator(s) must be fitted to each appliance gas connection when installed

Water connection

Cold water connection
1 x 1/2" O.D. copper tube
475mm from rear, 325mm from floor, 106mm from LH side

Drain connection

Connection to waste drain or drain to collection vessel
1-1/4" BSP drain waste
107mm from rear, 647mm from floor, 203mm from LH side

Dimensions

Width 600mm
Depth 800mm
Height 771mm
Incl. splashback 1280mm

Nett weight

78kg

Packing data

0.76m³, 128kg
Width 635mm
Depth 865mm
Height 1382mm

Gas types

Available in Natural gas and LP gas, please specify when ordering



Cert. No. AGA 6878G

moффat.com.au

moффat.co.nz

Australia
moффat.com.au

Moffat Pty Limited

Victoria/Tasmania
740 Springvale Road
Mulgrave, Victoria 3170
Telephone +613-9518 3888
Facsimile +613-9518 3833
vsales@moffat.com.au

New South Wales
Telephone +612-8833 4111
nswsales@moffat.com.au

South Australia
Telephone +613-9518 3888
vsales@moffat.com.au

Queensland
Telephone +617-3630 8600
qldsales@moffat.com.au

Western Australia
Telephone +618-9413 2400
wasales@moffat.com.au

New Zealand
moффat.co.nz

Moffat Limited

Rolleston
45 Illinois Drive
Izone Business Hub
Rolleston 7675
Telephone +64 3-983 6600
Facsimile +64 3-983 6660
sales@moffat.co.nz

Auckland
Telephone +64 9-574 3150
sales@moffat.co.nz



ISO9001
Quality
Management
Standard

Designed and manufactured by



ISO9001

All Cobra products are designed and manufactured by Moffat using the internationally recognised ISO9001 quality management system, covering design, manufacture and final inspection, ensuring consistent high quality at all times.

In line with policy to continually develop and improve its products, Moffat Limited reserves the right to change specifications and design without notice.

© Copyright Moffat Ltd
AN.C.01.19 / 1598

an Ali Group Company



The Spirit of Excellence